

Telstra T310 Telephone

User Guide



If you have any problems with your phone, firstly refer to the Help section of this User Guide or call the TechHelp line on 1300 369 193.



TechHelp
1300 369 193

Introduction

to your Telstra T310 Telephone

Calling Number Display*

Lets you identify the callers telephone number (except for blocked calls), enabling you to screen your calls.

Handsfree operation

You can conduct your call over the loudspeaker without lifting the handset

Name & number phonebook

Store up to 25 of your important or frequently dialled numbers in the Phonebook. You can also store names to go with the numbers. It is then easy to display and dial numbers from the Phonebook.

Call indicator light

Visually alerts you to an incoming call

Adjustable ringer volume & tone control

The ringer volume and pitch can be adjusted to your appropriate levels

Alarm clock

The date and time are displayed on the LCD when the phone is idle. You can set the alarm ring at your desired time.

12 month warranty

* Charges apply. Service available in most areas.



This User Guide provides you with all the information you need to get the most from your phone.

Before you make your first call you will need to set up your phone. Follow the simple instructions on the next few pages.

Need help?

If you have any problems setting up or using your Telstra T310 please contact the TechHelp line on 1300 369 193.

Alternatively, you may find the answer in 'Help' at the back of this guide.

Got everything?

- Telstra T310 Telephone
- Telephone Line Cord
- AC Power Adaptor
- Telephone Adaptor Plug
- Wall Mounting Bracket

Welcome to your Telstra T310 Telephone	1
In this guide	3
Installing your Telstra T310	4
Wall mounting your Telstra T310	5
Getting to know your Telstra T310	6
Using your Telstra T310	8
Making and receiving calls	8
Call Timer	8
Redial	9
Mute	9
Handsfree operation	10
Recall	11
Phonebook	11
Ringer volume and tone settings	15
Alarm clock	17
Network information	20
Calls list	21
Call Waiting	24
Telstra Voice Assistant	26
Help	27
Important Safety Instructions	28
General Information	28
Product warranty & Customer service	29
Wall mounting template	30

You can also wall mount your Telstra T310, for more information see page 5.

1. Connect AC Adaptor to the base and power socket as shown.

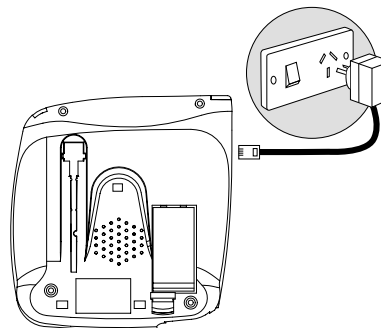

2. Connect one end of the Telephone Line Cord into the socket at the bottom of the base. Connect the other end of the Telephone Line Cord into the telephone wall socket.

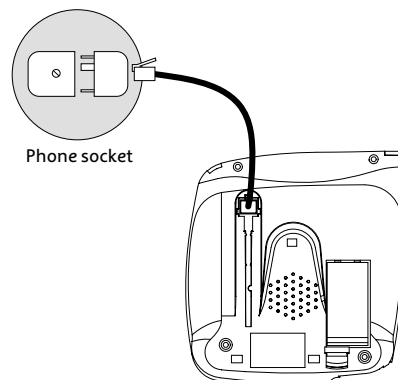

Make sure all the connections are firmly in place.

Your telephone is now ready to use.

Depending on your wall socket, you may need to use the telephone adaptor plug supplied.

Your TelstraT310 can be wall mounted by screwing directly onto a wall or can be fitted to a standard telephone wall mount plate.

Screwing onto a wall

1. Using the template on page 30, drill 2 holes 25mm deep using a 3mm drill.
2. Insert the wall plugs and insert a screw into each hole. Leave 2-3mm between the head of the screw and the wall.
3. Position the product onto the screws.
4. Slide down to secure.

Mounting onto a standard telephone wall plate

1. With the wall bracket installed, position the product onto the mounting studs on the wall plate.
2. Slide down to secure.

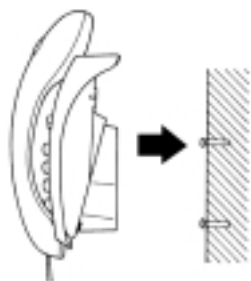

Handset Hook

This hook keeps the handset in when the T310 is wall mounted. Revolve the handset catch on the base unit. The handset will now be able to rest on the hook when wall mounted.

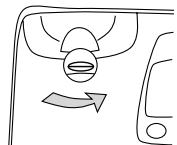

Ensure that you do not drill into any hidden wiring or pipes

For mounting on a wall plate, you may wish to purchase a short line cord.

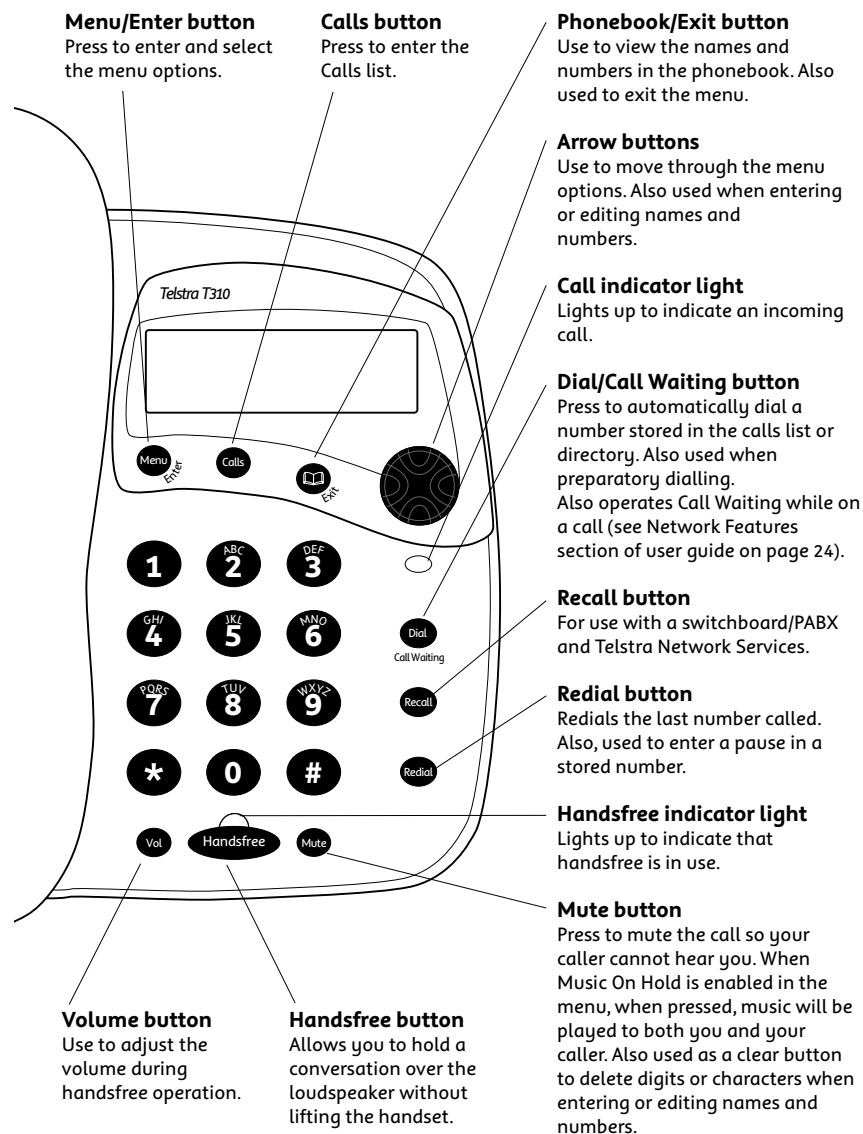

Explanation of display icons

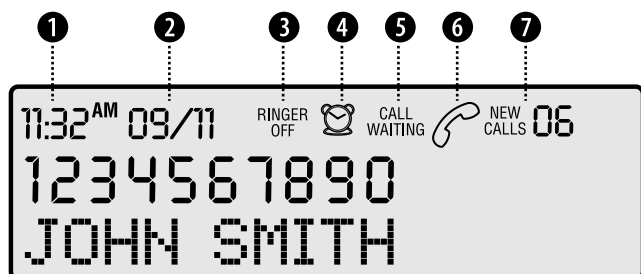
**1 Time 2 Date**

The time and date can be set manually, see page 17. Alternatively, if you have subscribed to a Calling Number Display Service, the first call you receive will automatically update the time and date. The time and date will also be displayed in the calls list to indicate when each call was received.

3 Ringer Off

This will be displayed to remind you the ringer is set to off.

4 Alarm set

This will be displayed when the alarm is set to ON.

5 Call Waiting

This will flash to indicate you have a caller waiting. This will also be displayed in the calls list to indicate the entry was a waiting caller.

6 Phone in use/Call answered

This will be displayed when the phone is in use. It will also be displayed in the calls list to indicate the call was answered.

7 New unviewed calls in the calls list

Displays the number of new calls received since you last viewed the calls list. It will also display the total number of calls stored in the calls list.

Making and receiving calls

To make a call

1. Lift the handset and wait for the dial tone.
2. Dial the telephone number.

The  will be shown on the display to indicate that the phone is in use.

Or

Preparatory dialling.

1. Dial the telephone number without lifting the handset. It is shown on the display but not dialled.
2. Press the  button. The number will be dialled automatically using handsfree.



If you wish to speak to your caller privately you can pick up the handset at any time.

To receive a call

1. When the telephone rings, the call indicator light will flash to indicate that there is an incoming call. Simply pick up the handset.

Call timer

Your T310 automatically times the duration of all outgoing and incoming external calls. The call duration will be shown both during the call and for a few seconds after it is completed.

If you enter any digits incorrectly, use the  LEFT or RIGHT arrow button to move to the digit and press the  button to delete.

If there is no number stored in the redial memory, the display will show NO REDIAL.

A redial number can be no longer than 32 digits.

Redial

To redial the last number called

1. Lift the handset. Press the  button.

The last number called is dialed automatically.

If the  button is pressed when the handset is down, the display will show the number and REDIAL.

Press the  button and the number will be dialed automatically using handsfree.

Mute

When on a call you can talk to someone in the same room, without your caller hearing.

To switch mute on and off

1. During a call press and release the  button. The call indicator light will flash to show that mute is on.

Your caller will be put on hold and both you and the caller will hear music until the  button is pressed again. You can now talk to someone in the room without your caller hearing you.

The display will flash MUTE to indicate that mute is on.

2. Press and release the  button again to return to your caller.

Handsfree Operation

The handsfree feature allows you to use the phone without picking up the handset, giving you more freedom when you are speaking on the phone. You can hear the caller's voice through the in-built speaker. You can also switch to handsfree mode during a call by pressing the  button and replacing the handset.

To make a handsfree call

1. Press the  button.

The handsfree light will come on and HANDSFREE will be displayed for 5 seconds. You will hear the dial tone.

2. Dial the telephone number.



3. To end your call, press the  button.

To receive a call using handsfree

1. Press the  button when the phone rings.

To change the volume when using handsfree

You can adjust the speaker volume when you are on a handsfree call.

1. Press the  button. The volume level will be shown on the display VOLUME HANDSFREE.
2. Press the  button to move up and down each level.

You can pick up the handset at any time if you wish to speak to your caller privately.

There are 5 levels to choose from. The display will show the volume level as you adjust it. The selected volume level will remain until changed.

To use the Recall button

You may need to use the RECALL button if you are connected to a switchboard/PABX, contact your PABX supplier for further information.

The  button is also used for Telstra Network Services. For more information on Telstra's Network Services call 13 2200.

Phonebook

You can store up to 25 of your most frequently used names and numbers in the phonebook.

You can also select a group under which you want to store the number, e.g. NORMAL, FAMILY, FRIENDS or VIP. You can then select a different ring tone for each group, see 'To set the ringer tone', page 15.

To store a name and number in the Phonebook

1. Press the  button.

The display will show ADD ENTRY

2. Press the  button again.

The display will show how many entries are stored already, e.g. ENTRIES: 10.



The display will then show ENTER NAME, followed by a flashing cursor.

3. Enter the name using the letters on the keypad.

Entering names:

4. Use the keypad letters to enter names. To move to the next character press the  RIGHT arrow button once. (Maximum 15 characters.)

If the phonebook is full, the display will show MEMORY FULL.

If you enter a character or digit incorrectly you can use the  LEFT or RIGHT arrow button to move the cursor to the character and delete it by pressing the  button.

For example, if you wish to store the name TOM

To enter the letter T, press the  button once.

Press the  RIGHT arrow button.

To enter the letter O, press the  button three times.

Press the  RIGHT arrow button.

To enter the letter M, press the  button once.

Press the  button to confirm the entry.

The display will show ENTER NUMBER

Enter the telephone number you want to store. (Maximum 18 digits.)

Press the  button to confirm the entry.

The display will show e.g. GROUP: NORMAL

5. Use the  LEFT or RIGHT arrow button to select the ringer tone group you wish to store your entry in (NORMAL, FAMILY, FRIENDS or VIP.)

6. Press the  button to confirm. The display will show SAVED and you will hear a confirmation tone.

The display will show ADD ENTRY

7. Press the  button again to store another entry in the phonebook

Or

Press the  button to return to the normal display.



You can also select a different ring tone for each group, see 'To set the ringer tone', page 15.

To search alphabetically, press the relevant keypad number, for example to find TOM, press the 8 button once and scroll through the entries under T.

The display will show END OF LIST if you reach the end of the phonebook.

You can exit the phonebook and return to the normal display by pressing the  button at any time.









To dial a number from the phonebook

1. Press the  button.
2. Use the  UP or DOWN arrow button to find the entry you want to dial.
3. Press the  button to dial the number.

The number will be dialed automatically using handsfree.



You can pick up the handset at anytime if you wish to speak to your caller privately.

To edit phonebook names and numbers

1. Press the  button.
2. Use the  UP or DOWN arrow button to find the entry you want to edit.
3. Press the  button to confirm.
4. Use the  UP, DOWN, LEFT or RIGHT arrow buttons to move to the digits or letters you want to edit. The selected digit or character will flash.
5. Use the  button to delete numbers or letters and enter new ones using the numbers/letters on the keypad.
6. Press the  button to store the new entry.
7. Use the  LEFT or RIGHT arrow button to select the ringer tone group, e.g. NORMAL, FAMILY, FRIENDS or VIP.
8. Press the  button.

The display will show SAVED and you will hear a confirmation tone.

To delete an entry from the phonebook

1. Press the  button.
2. Use the  UP or DOWN arrow button to find the entry you want to delete.
3. Press the  button twice.

The display will show DELETE ENTRY?





4. Press the  button again to confirm.

The display will show DELETED and you will hear a confirmation tone.

5. Press the  button to return to the normal display.

To adjust the ringer volume

There are 3 volume levels to choose from: HIGH, LOW or OFF. The default setting is HIGH.

1. Press the  button.
2. Use the  DOWN arrow button to scroll to RINGER LEVEL.
3. Press the  button. The display will show HIGH, LOW, OFF and the current setting will flash.
4. Use the  LEFT or RIGHT arrow button to select the required level.
5. Press the  button to confirm.

The display will show SAVED and you will hear a confirmation tone.





6. Press the  button to return to the normal display.

If the ringer is set to OFF the display will show RINGER OFF. The call indicator light will still flash to indicate someone is calling you.

To set the ringer tone

There are 4 ringer tones to choose from: TYPE 1-4. The default setting is TYPE 1.

You can select a different ring tone for each group in your phonebook so you will have an indication of who is calling you when the phone rings, e.g. NORMAL, FRIEND, FAMILY or VIP.

1. Press the  button.
2. Use the  DOWN arrow button to scroll to RINGER TYPE
3. Press the  button. The display will show the ring group and tone, e.g: NORMAL TYPE 1 You will hear a sample tone.
4. Use the  LEFT or RIGHT arrow button to select the required tone for the ringer group displayed (TYPE 1-4). You will hear a sample tone.
5. Press the  button to confirm the tone you want.

The display will show SAVED and you will hear a confirmation tone.







The display will show the next caller group, e.g: FRIEND TYPE 2

Repeat these instructions to set the ring tones for the remaining caller groups.

6. Press the  button at any time to return to the normal display.

To change the name of a ringer group

You may wish to change the names of the ringer groups, for example you may want to name one of them WORK if you work from home. (Maximum 7 characters.)

1. Press the  button.
2. Use the  DOWN arrow button to scroll to RINGER TYPE
3. Press the  button.
4. Press the  UP or DOWN arrow button to select the group name you wish to change.
5. Press and hold the  button for 6 seconds. The selected group name is deleted.
6. Enter a new name using the letters on the keypad.
7. Press the  button twice.

The display will show SAVED and you will hear a confirmation tone.









Follow these instructions for changing any of the other ringer group names.

If you have subscribed to a Calling Number Display Service, the first call you receive will automatically update the time and date.

Alarm clock

You can use your Telstra T310 telephone as an alarm clock. You must set the date and time before the alarm will work.





To set the date and time

1. Press the  button.
2. Use the  DOWN arrow button to scroll to SET DATE TIME
3. Press the  button. ENTER HOUR will be displayed and the hour digits will flash.
4. Enter the hour (12 hour clock).
5. Press the  button to confirm the entry. ENTER MINUTE will be displayed and the minute digits will flash.
6. Enter the minutes.
7. Press the  button to confirm the entry. The display will flash AM or PM
8. Use the  LEFT or RIGHT arrow button to select either AM or PM.
9. Press the  button to confirm the entry. ENTER DAY will be displayed and the day digits will flash.
10. Enter the day, e.g. 20 for the 20th.
11. Press the  button to confirm the entry. ENTER MONTH will be displayed and the month digits will flash.
12. Enter the month, e.g. 12 for December.





13. Press the  button to confirm. The display will show SAVED and you will hear a confirmation tone.

14. Press the  button to return to the normal display.

To set the alarm



1. Press the  button.
2. Use the  DOWN arrow button to scroll to SET ALARM
3. Press the  button. The display will show ALARM ON OFF
4. Use the  LEFT or RIGHT arrow button to select either ON or OFF

If you select OFF, the display will flash OFF

5. Press the  button to confirm. The display will show SAVED
6. If you select ON, press the  button. ENTER HOUR will be displayed and the hour digits will flash.
7. Enter the hour (12 hour clock).
8. Press the  button to confirm the entry. ENTER MINUTE will be displayed and the minute digits will flash.
9. Enter the minutes.
10. Press the  button to confirm entry. The display will flash AM or PM

If the alarm setting is currently ON, the alarm time set will be displayed and ON will flash.

The alarm will ring daily at the time set until the setting is turned off.

11. Use the  LEFT or RIGHT arrow button to select either AM or PM
12. Press the  button to confirm. The display will show SAVED and you will hear a confirmation tone.
13. Press the  button to return to the normal display.

The  icon will be displayed to indicate the alarm is set to ON

To switch the alarm off

The alarm will ring at the set time, and the  icon will flash.

To switch the alarm off press the  button or lift the handset.

Calling Number Display

Your T310 receives and displays caller information, which is transmitted over the network. This information will include the date and time the call is received, and in most cases the caller's phone number. If the name of the person calling you has been stored in your T310's phonebook, the name of the caller will also be displayed.

Your T310 will also display the caller's details when you are engaged on another call. The date and time will be set automatically the first time you receive a call, provided that you have subscribed to Telstra's Calling Number Display Service.

Calls list

Whether you take a call or not, the caller's details are automatically stored in the calls list. The calls list holds a maximum of 30 calls. You can display, scroll through and dial numbers in the calls list and copy them into the directory.

If a call is received when the calls list is full then the oldest entry will be deleted automatically so the new call can be stored.

New call indicator

The new calls indicator displays the number of unanswered calls you have received, and which have not been viewed yet, e.g. the display will show NEW CALLS 03. Once you have viewed a call in the calls list it will be removed from the new call indicator. If there are no new unanswered calls, the display will show the number of calls in the list, e.g. CALLS 25.

IMPORTANT

To enable your T310 to display this information, you will first have to subscribe to Telstra's Calling Number Display and Call Waiting Service.

For more information on Telstra Network Services call 13 22 00.

Please ensure that you have stored the full telephone number, including the area code, otherwise the incoming callers number will not match the number stored in the phonebook.

If the call was answered, the  icon will appear on the display. If the call was a waiting caller, CALL WAITING will appear on the display.

Calls List

To view the calls list

1. Press the  button.

The most recently received number will be displayed.



2. Use the  UP or DOWN arrow button to scroll backwards and forwards through the calls list.

If you reach the end of the list, the display will show END OF LIST

To dial a number from the calls list

1. Press the  button.





The most recently received number will be displayed.

2. Use the  UP or DOWN arrow button to find the number you want to dial.
3. When the number you wish to call is displayed, press the  button.

The number will be dialed automatically.

To copy a number from the calls list into the phonebook

You can add a name to a number, so when they call again both the name and number will be shown on the display.

1. Press the  button.
2. Use the  UP or DOWN arrow button to find the number you want to copy.
3. Press the  button. The display will show ENTER NAME
4. Enter the name using the letters on the keypad.
5. Press the  button to confirm.

The display will show GROUP:NORMAL





6. Use the  LEFT or RIGHT arrow button to select the ringer tone group you wish to store your entry under (NORMAL, FAMILY, FRIENDS or VIP).

You will hear a sample tone.



7. Press the  button to confirm. The display will show SAVED and you will hear a confirmation tone.

The name and number is now stored in the phonebook.

To delete a number in the calls list

1. Press the  button.
2. Use the  UP or DOWN arrow button to find the number you want to delete.
3. Press the  button twice. The display will show `DELETE ENTRY?`
4. Press the  button to confirm. The display will show `DELETED` and you will hear a confirmation tone.

To delete the entire calls list

1. Press the  button.
2. Press and hold the  button for about 6 seconds.

The display will show `DELETE ALL?`

3. Press the  button to confirm.

The display will show `LIST EMPTIED`

Caller information not available

With some incoming calls the telephone number of the caller is not available and cannot therefore be displayed. In this case, your T310 provides you with some explanatory information about the type of call received. This will be in the form of a text message and will be one of the following.

`UNAVAILABLE` The number is unavailable.

`WITHELD` The caller has withheld their number.

`PAYPHONE` The caller is ringing from a payphone.

`INTERNATIONAL` International call.

Call Waiting

While you're on a call, the Call Waiting tone (two beeps every 5 seconds) lets you know that there is a second incoming call. You then have 45 seconds in which to place your current call on hold and respond to the second call (the second callers hears ringing tone). Once Call Waiting is turned on, it stays on until you turn it off.

Call Waiting – Calling Number Display

Your Telstra T310 is capable of displaying the number (or name if the callers information is stored in your Phonebook) of the second calling party while you are on the telephone.

To turn Call Waiting on

1. Lift handset
2. Dial    

You will hear a confirmation tone

3. Replace handset

To turn Call Waiting off

1. Lift handset
2. Dial    

You will hear a confirmation tone

3. Replace handset

Alternatively you can use the Telstra Voice Assistant Service to activate and de-activate Call Waiting. See page 26 for further instructions

Answering a waiting call

To put the 1st caller on hold and talk to the 2nd caller

1. Press the  button.

You will be automatically connected to the 2nd caller



To alternate between callers

1. Press the  button

To hang up on one caller and return to the remaining caller

1. Hang up handset and wait for phone to ring
2. When phone rings answer and you are connected to remaining caller



OR

1. Press  button followed by  on the keypad

This will disconnect one caller and return you to the remaining caller

Telstra Voice Assistant

Telstra's Voice Assistant Service can help you activate and de-activate Telstra Phone Features e.g. Call Waiting and Call Forward. To utilise this service on your Telstra T310 simply

1. Lift the handset, or press 
2. Dial  then  on the telephone keypad
3. Follow the voice prompts.

If you have any difficulty using your Telstra T310, this section provides solutions to the most common problems.

No dial tone

- Make sure the telephone line cord is plugged into the telephone socket at the back of the unit and that the telephone line cord is connected to your wall socket.
- Check that no other extension is in use.

Display screen not functioning properly or goes blank

- Check whether the battery is fitted correctly.

Calling Number Display not displaying incoming numbers

- To be able to receive and display messages, you must subscribe to the Calling Number Display Service from your Network Provider.

Phone does not ring

- Check that the ringer is not switched off on your T310.
- Check that no other connected phones are off the hook.
- Check whether you have too many phone extensions in your home or office.

Important safety instructions

Read and understand all instructions.

Follow all warnings and instructions marked on this product.

Do not use this product during an electrical storm, as it is possible to get a shock.

Do not use this product when near water, or when wet.

Make sure the line cords are protected from damage.

Keep the product away from heaters and away from sunlight.

Do not use this telephone near flammable gases or liquids.

Slots and openings in the cabinet are provided for ventilation, to protect it from overheating. Ensure these are not blocked or covered.

Do not open the unit. There are no user serviceable parts inside. Warranty conditions will not apply if the unit has been opened.

Unplug this unit before cleaning. Do not use detergents or sprays. To clean the outside plastic parts, use only a damp cloth.

Do not push objects into ventilation openings. This could cause an electrical shock.

General information

This Unit complies with Australian Communications Authority Technical Standards. If the quantity of ringing devices connected to the telephone line exceeds a REN of 3, it may result in some devices not ringing in response to an incoming call. To check the REN of each device, refer to the base label.

Product Warranty

Telstra Guarantees your product for 12 months from date of purchase against any defect in materials or workmanship under conditions of normal use and service and subject to proof of the date of purchase being provided and subject to the conditions specified in this user agreement. The benefits conferred by this warranty are in addition to all other rights and remedies in respect of the product that the consumer has under the Trade Practices Act and similar State and Territory laws.

Warranty Service Conditions

Subject to your statutory rights referred to above, Telstra expressly limits its liability with respect to its products to the person who purchases the Product from the Telstra authorised retailer.

Subject to your statutory rights referred to above, Telstra expressly limits its liability with respect to its products to whichever is the lowest amount out of:

- A. The cost of having the goods repaired
- B. The cost of replacing the goods: or
- C. The cost of obtaining equivalent goods.

Subject to your statutory rights referred to above, in the event of the goods requiring service under warranty, the owner is responsible for the cost of transportation to the authorised service organisation. Whilst in transit the goods are at the owner's risk. Subject to your statutory rights referred to above, should the goods be found to be in sound working order by the authorised service organisation the owner may be charged a service fee.

Subject to your statutory rights referred to above, the goods will not be eligible for service under this warranty if:

- A. Proof of date of purchase cannot be provided;
- B. The goods are not branded Telstra;
- C. The goods have been rented to another person;

- D. The defect was caused by an accident, misuse, abuse, improper installation or operation, lack of reasonable care, unauthorised modification, loss of parts, tampering or attempted repair by a person not authorised by Telstra.
- E. The product has been damaged by lightning or a mains power surge.

Do you really need service?

Before calling for service under this warranty have you :

Checked that all cables are securely connected as detailed in the User Guide.

Referred to the User Guide to ensure that the features are being used correctly.

If you are trying to access a network service such as Call Waiting, confirmed with your network provider that you have access to this feature.

If You Require Warranty Service

To obtain service during the terms of this warranty:

Call the Product Information Line (1300 369 193) for advice and assistance on the repair of your product, or contact us by E-mail at:

tcpsupport@techpac.com

After consulting our operators, should it be deemed necessary to have the product serviced, the operator will inform you of your nearest authorised service organisation and provide a Return Authority Number.

Please ensure that :

- A. You provide proof of the date of purchase
- B. That your product is suitably packaged (Preferably in original packaging)
- C. That you have included all components from the original purchase:
- D. That you provide details of the Return Authority Number

IMPORTANT

Please retain this booklet with your sales receipt as proof of the date of purchase.

© COPYRIGHT 2004 Telstra Corporation Limited

This work is copyright. All rights reserved. Other than for purposes and subject to conditions prescribed under the Copyright Act, no part of it may in any form or by any means (electronic, mechanical, photo copying, microcopying, scanning, recording or otherwise) be reproduced, stored in a retrieval system or transmitted without prior permission from Telstra Corporation Limited ABN 33 051 775 556

™ Trade Mark of Telstra Corporation Limited

® Registered Trade Mark of Telstra Corporation Limited



TechHelp is your guarantee of superior customer service for these products. Your customer service options are:

- Product Information Line 1300 369 193
- 12 Month Product Warranty

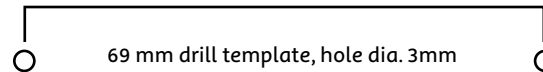



www.telstra.com

